

vanEsch

LOCKERS



“Welcome. We are van Esch. We master the craft of creating the perfect entrance. We make coat racks, lockers, brochure stands, display cabinets and waste bins. In fact, our family business has been doing it since 1972. By joining forces with top designers we develop high quality and tailor-made solutions for every entrance or reception area. Made in our factory in Goirle, The Netherlands.”

AQUARIUS WOODEN LOCKERS 02
WOODEN WARDROBE LOCKERS 14
WOODEN COMPARTMENT LOCKERS 16
WOODEN MAILBOX LOCKERS 18
COLOURS 20
LOCKS 23
ACCESSORIES 24

AQUARIUS STEEL LOCKERS 26
STEEL WARDROBE LOCKERS 38
STEEL Z-SHAPED LOCKERS 44
STEEL COMPARTMENT LOCKERS 46
COLOURS 48
STEEL MAILBOX LOCKERS 49
LOCKS 50
ACCESSORIES 51

ATLANTIS STEEL LOCKERS 52
STEEL WARDROBE LOCKERS 60
STEEL Z-SHAPED LOCKERS 62
STEEL COMPARTMENT LOCKERS 64
COLOURS AND ACCESSORIES 66

WOODEN LOCKERS
AQUARIUS H

Design: van Esch team, The Netherlands



WOODEN LOCKERS

AQUARIUS H

Design: van Esch team, The Netherlands

Grote kasten, kleine kastjes, postvakken naast elkaar of boven elkaar. De lockers uit het programma Aquarius zijn door de vele mogelijkheden erg functioneel. De strak vormgegeven romp is uitgevoerd in wit. Deuren en zijpanelen zijn verkrijgbaar in circa 160 verschillende kleuren of houtdecors. De kasten zijn voorzien van een zwarte metalen plint met stelvoeten.

Large lockers, small cabinets, pigeon holes, alongside or one above the other. The lockers from the Aquarius series are thanks to the many possibilities highly functional. The sleek body is finished in white. Doors and side panels are available in approximately 160 different colours and wood effects. The models come with black metal plinths and adjustable feet.

Große Schränke, kleine Schränke, Postfächer neben- oder übereinander. Die Schränke aus dem Programm Aquarius sind verfügen über zahlreiche funktionelle Gestaltungsmöglichkeiten. Den geradlinig gestalteten Korpus gibt es in Weiß. Türen und Seitenteile sind in etwa 160 verschiedenen Farben oder Holzoptiken erhältlich. Die Schränke sind mit einer schwarzen Sockel aus Metall und Stellfüßen versehen.

Grandes armoires, petites armoires, boîtes aux lettres juxtaposées ou superposées. Les casiers de la gamme Aquarius sont très fonctionnels par leurs nombreuses possibilités d'utilisation. Le corps au design sobre est réalisé en blanc. Les portes et les panneaux latéraux de finition sont disponibles dans environ 160 couleurs ou décors bois différents. Les armoires sont pourvues d'une plinthe métallique noire avec pieds réglables.



2x Aquarius HV2404/P





The Rise
Tilburg, The Netherlands
4x Aquarius HV2404/P



Municipality Utrechtse Heuvelrug
Doorn, The Netherlands
2x Aquarius HV2404/P special, 1x Aquarius HV1404/P special



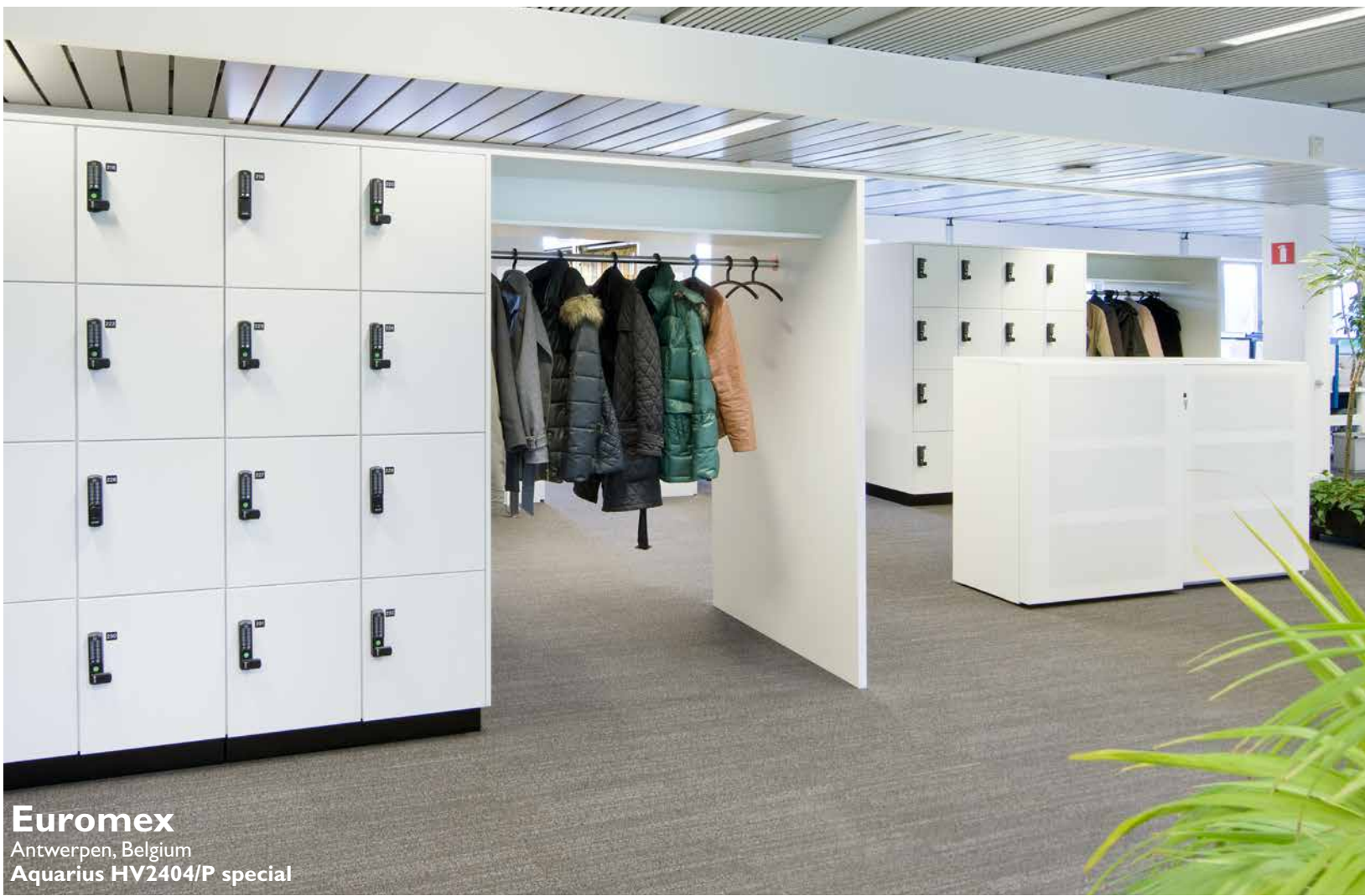

Euromex
Antwerpen, Belgium
Aquarius HV2404/P special



Youth services
Amsterdam, The Netherlands
14x Aquarius HVL2403/P





5x Aquarius HP1304 1x Aquarius OS150/72



Alcoa
Rotterdam, The Netherlands
4x Aquarius HV2404/P special + 1x Aquarius HVI404/P special + 2x HG2402/P special



WOODEN WARDROBE LOCKERS AQUARIUS HG



STANDARD COLOURS 4 COLOURS

Specificaties

- Hoge kwaliteit locker
- Perfect voor projectgebruik
- Standaard met cilindersloten en 2 sleutels per compartiment
- Verzinkt stalen plint in zwart
- Witte romp
- Stelvoeten
- Ventilatie in de achterwand
- Inclusief legbord en hangerroede
- Zelfsluitende deuren met gedempte scharnieren
- Diverse sluitingsmogelijkheden
- Eindelooze opties
- Vrijstaande lockers? We hebben panelen voor de zijkant, bovenkant en achterkant.

Specifications

- High-quality locker
- Perfect for project use
- Supplied with cylinder locks and 2 keys for each compartment as standard
- Galvanised black steel plinth
- White body
- Adjustable feet
- Rear-wall ventilation
- Including shelf and hanging rod
- Self-closing doors with dampening hinges
- Various locking options
- Infinite options
- Need free-standing lockers? We have side, top and rear panels.



UNI COLOURS > 90 COLOURS

Spezifikationen

- Qualitativ hochwertige Schrank
- Perfekt für Raumkonzepte
- Standardmodell mit Zylinderschloss und 2 Schlüsseln pro Fach
- Verzinkter Stahlsockel Farbe Schwarz
- Weißer Korpus
- Verstellbare Füße
- Lüftung in der Rückwand
- Einschließlich Einlegeboden und Kleiderstange
- Selbstschließende Türen mit gedämpften Scharnieren
- Verschiedene Schließmöglichkeiten
- Endlose Möglichkeiten
- Freistehende Schließfächer? Wir haben Paneele, mit denen die Schränke seitlich, oben und hinten verkleidet werden können.

Spécifications

- Casier de qualité supérieure
- Parfait pour les projets
- Avec, de manière standard, des serrures à cylindre et 2 clés par compartiment
- Plinthe en acier galvanisé noir
- Corps blanc
- Pieds réglables
- Ventilation dans la paroi arrière
- Étagère et tringle comprises
- Portes à fermeture automatique avec charnières amorties
- Diverses possibilités de fermeture
- Options infinies
- Des casiers indépendants ? Nous avons des panneaux pour les côtés, le dessus et l'arrière.



WOOD EFFECTS > 65 EFFECTS

MODELS AQUARIUS HG

HG1301/P
HG1401/P

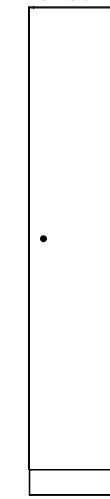

30/40 cm

HG2301/P
HG2401/P

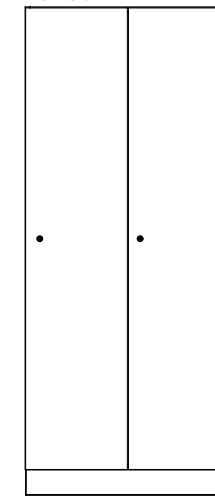

60/80 cm

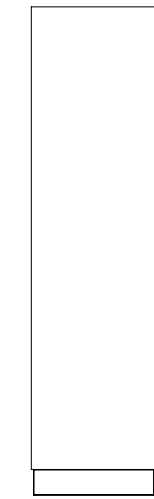

52 cm

190 cm

10 cm

HG1302/P
HG1402/P



30/40 cm

HG2302/P
HG2402/P

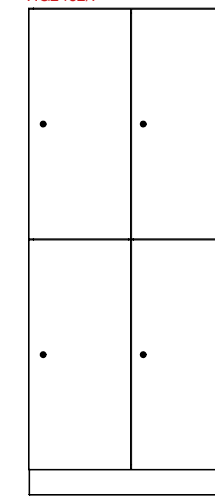

60/80 cm

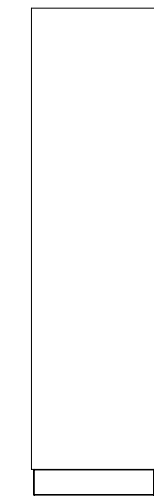

52 cm

190 cm

10 cm

WOODEN COMPARTMENT LOCKERS AQUARIUS HV



STANDARD COLOURS 4 COLOURS

Specificaties

- Hoge kwaliteit locker
- Perfect voor projectgebruik
- Standaard met cilindersloten en 2 sleutels per compartiment
- Verzinkt stalen plint in zwart
- Witte romp
- Stelvoeten
- Zelfsluitende deuren met gedempte schamieren
- Diverse sluitingsmogelijkheden
- Eindelooze opties
- Vrijstaande lockers? We hebben panelen voor de zijkant, bovenkant en achterkant.

Specifications

- High-quality locker
- Perfect for project use
- Supplied with cylinder locks and 2 keys for each compartment as standard
- Galvanised black steel plinth
- White body
- Adjustable feet
- Self-closing doors with dampening hinges
- Various locking options
- Infinite options
- Need free-standing lockers? We have side, top and rear panels.



UNI COLOURS > 90 COLOURS

Spezifikationen

- Qualitativ hochwertige Schrank
- Perfekt für Raumkonzepte
- Standardmodell mit Zylinderschloss und 2 Schlüsseln pro Fach
- Verzinkter Stahlsockel Farbe Schwarz
- Weißer Korpus
- Verstellbare Füße
- Selbstschließende Türen mit gedämpften Schamieren
- Verschiedene Schließmöglichkeiten
- Endlose Möglichkeiten
- Freistehende Schließfächer? Wir haben Paneele, mit denen die Schränke seitlich, oben und hinten verkleidet werden können.

Spécifications

- Casier de qualité supérieure
- Parfait pour les projets
- Avec, de manière standard, des serrures à cylindre et 2 clés par compartiment
- Plinthe en acier galvanisé noir
- Corps blanc
- Pieds réglables
- Portes à fermeture automatique avec charnières amorties
- Diverses possibilités de fermeture
- Options infinies
- Des casiers indépendants ? Nous avons des panneaux pour les côtés, le dessus et l'arrière.



WOOD EFFECTS > 65 EFFECTS

MODELS AQUARIUS HV

HV1303/P
HV1403/P

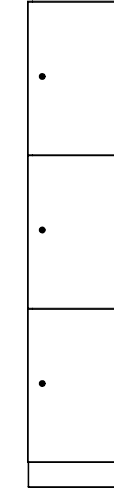

30/40 cm

HV2303/P
HV2403/P

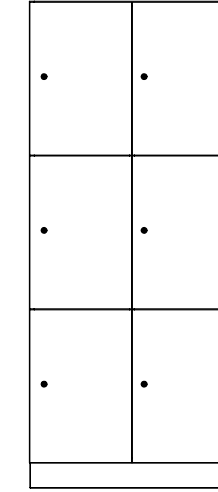

60/80 cm

HV1304/P
HV1404/P

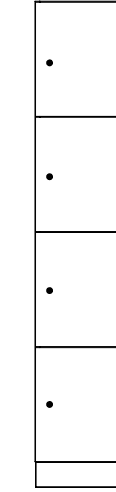

30/40 cm

HV2304/P
HV2404/P

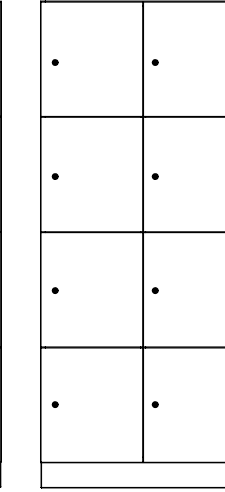

60/80 cm

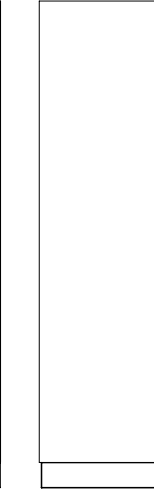

52 cm

190 cm

10 cm

HV1305/P
HV1405/P

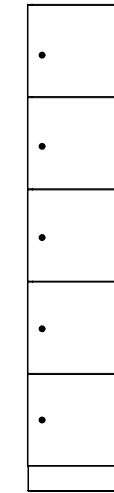

30/40 cm

HV2305/P
HV2405/P

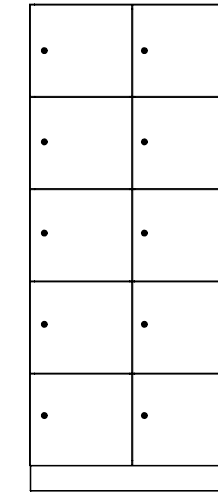

60/80 cm

HV1306/P
HV1406/P

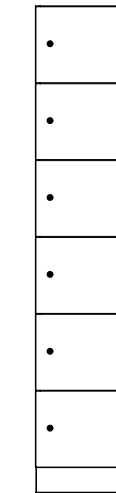

30/40 cm

HV2306/P
HV2406/P

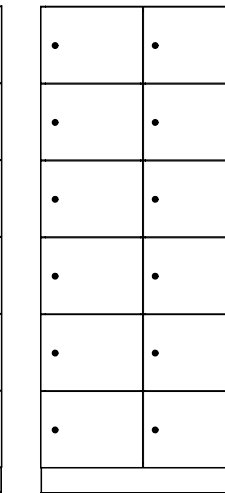

60/80 cm

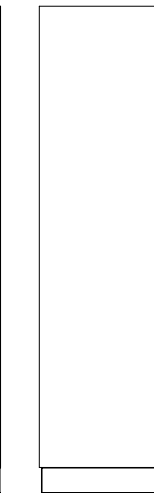

52 cm

180 cm

10 cm

HVL1302/P
HVL1402/P

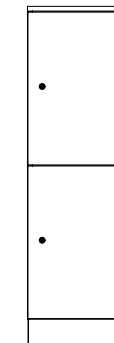

30/40 cm

HVL2302/P
HVL2402/P

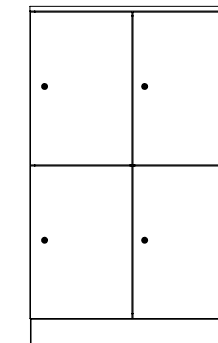

60/80 cm

HVL1303/P
HVL1403/P

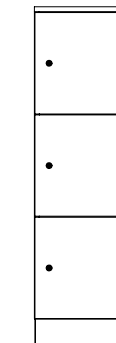

30/40 cm

HVL2303/P
HVL2403/P

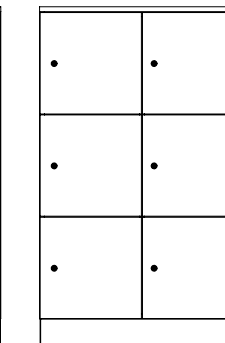

60/80 cm

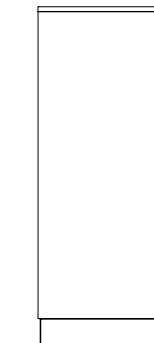

52 cm

132 cm

10 cm

WOODEN MAILBOX LOCKERS AQUARIUS HP



STANDARD COLOURS 4 COLOURS

Specificaties

- Hoge kwaliteit locker
- Perfect voor projectgebruik
- Standaard met cilindersloten en 2 sleutels per compartiment
- Witte romp
- Zelfsluitende deuren met gedempte schamieren
- Diverse sluitingsmogelijkheden
- Te combineren met een wandsteun of onderstel
- Eindelooze opties
- Vrijstaande lockers? We hebben panelen voor de zijkant, bovenkant en achterkant.

Specifications

- High-quality locker
- Perfect for project use
- Supplied with cylinder locks and 2 keys for each compartment as standard
- White body
- Self-closing doors with dampening hinges
- Various locking options
- Can be combined with a wall support or frame
- Infinite options
- Need free-standing lockers? We have side, top and rear panels.

UNI COLOURS > 90 COLOURS

Spezifikationen

- Qualitativ hochwertige Schrank
- Perfekt für Raumkonzepte
- Standardmodell mit Zylinderschloss und 2 Schlüsseln pro Fach
- Weißer Korpus
- Selbstschließende Türen mit gedämpften Schamieren
- Verschiedene Schließmöglichkeiten
- Mit Wandhalterung oder Untergestell
- Endlose Möglichkeiten
- Freistehende Schließfächer? Wir haben Paneele, mit denen die Schränke seitlich, oben und hinten verkleidet werden können.

Spécifications

- Casier de qualité supérieure
- Parfait pour les projets
- Avec, de manière standard, des serrures à cylindre et 2 clés par compartiment
- Corps blanc
- Portes à fermeture automatique avec charnières amorties
- Diverses possibilités de fermeture
- Peut être associé à un support mural ou à un élément de base
- Options infinies
- Des casiers indépendants ? Nous avons des panneaux pour les côtés, le dessus et l'arrière.

WOOD EFFECTS > 65 EFFECTS

MODELS AQUARIUS HP

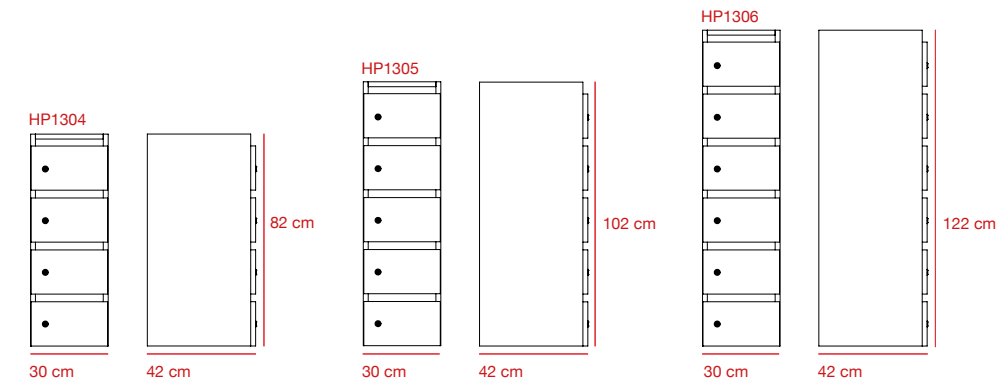

COLOURS

Naast de standaard kleuren wit, zwart en licht- of middelgrijs, zijn de deuren uitvoerbaar in meer dan 100 verschillende kleuren en houtdecors. Die je ook nog eens met elkaar kunt combineren.

In addition to the standard colours white, black and light or medium grey, the doors can be supplied in more than 100 different colours and wood effects. You are free to combine these at will.

Neben den Standardfarben Weiß, Schwarz, Hell- und Mittelgrau sind die Türen in mehr als 100 verschiedenen Farben und Holz Dekors erhältlich. Alle Farben und Dekors können miteinander kombiniert werden.

Outre les couleurs standards blanc, noir, gris clair et gris moyen, les portes sont disponibles dans plus de 100 couleurs et décors bois. Et vous pouvez associer décors et couleurs entre eux.

STANDARD COLOURS



97/85
White



97/74
Silvergrey



97/75
Medium grey



02/007
Black

UNI COLOURS



W10003
Str. MP



W10140
Str. MP



W10410
Str. MP



W10616
Str. VV



U11026
Str. VV



U11027
Str. VV



U11102
Str. VV



U11209
Str. VV



U11500
Str. MP



U11506
Str. VV



U11509
Str. VV



U11523
Str. MP



U12000
Str. MP



U12007
Str. MP



U12018
Str. MP



U12092
Str. MP



U12115
Str. MP



U12168
Str. VV



U12188
Str. MP



U12211
Str. MP



U12257
Str. MP



U12290
Str. MP



U15133
Str. MP



U15190
Str. VV



U15192
Str. MP



U15194
Str. MP



U15579
Str. MP



U16002
Str. VV



U16003
Str. VV



U16009
Str. VV



U16010
Str. MP



U16014
Str. VV



U16020
Str. MP



U16037
Str. MP



U16051
Str. MP



U16130
Str. MP



U16166
Str. MP



U16177
Str. VV



U16179
Str. VV



U16182
Str. MP



U17005
Str. MP



U17008
Str. MP



U17012
Str. VV



U17013
Str. VV



U17014
Str. VV



U17019
Str. VV



U17031
Str. MP



U17054
Str. MP



U17041
Str. MP



U17271
Str. MP



U17500
Str. MP



U17501
Str. VV



U17503
Str. VV



U17505
Str. VV



U18001
Str. MP



U18002
Str. MP



U18003
Str. MP



U18004
Str. MP



U18006
Str. VV



U18008
Str. VV



U18010
Str. VV



U18011
Str. VV



U18012
Str. VV



U18013
Str. VV



U18014
Str. VV



U18015
Str. VV



U18016
Str. VV



U18017
Str. VV



U18021
Str. VV



U18059
Str. MP



U18067
Str. MP



U18068
Str. MP



U18074
Str. MP



U18079
Str. MP



U18148
Str. MP



U18500
Str. VV



U18501
Str. VV



U18502
Str. VV



U18503
Str. VV



U18504
Str. VV



U18576
Str. MP



U19002
Str. VV



U19003
Str. VV



U19004
Str. VV



U19005
Str. VV



U19006
Str. VV



U19007
Str. VV



U19008
Str. VV



U19500
Str. MP



U19501
Str. VV



U19502
Str. VV



U19504
Str. MP



U19505
Str. VV



U19508
Str. VV



U19515
Str. VV

WOOD EFFECTS

 R20020 Str. MO	 R20021 Str. ML	 R20027 Str. RU	 R20031 Str. RU	 R20033 Str. RU	 R20038 Str. MO	 R20064 Str. MO	 R20065 Str. MO	 R20074 Str. RU
 R20095 Str. MO	 R20119 Str. ML	 R20128 Str. RU	 R20134 Str. MO	 R20147 Str. ML	 R20167 Str. ML	 R24029 Str. ML	 R24030 Str. ML	 R24031 Str. ML
 R24053 Str. NW	 R27001 Str. VV	 R27017 Str. VV	 R27024 Str. VV	 R27039 Str. MO	 R27043 Str. ML	 R30011 Str. MO	 R30013 Str. MO	 R30019 Str. VV
 R30021 Str. RU	 R30039 Str. MO	 R30042 Str. MO	 R30061 Str. ML	 R30110 Str. MO	 R34014 Str. MO	 R35003 Str. VV	 R35013 Str. ML	 R35014 Str. ML
 R35018 Str. ML	 R36002 Str. NW	 R36012 Str. VV	 R37001 Str. ML	 R37003 Str. ML	 R37005 Str. ML	 R38002 Str. RU	 R42006 Str. VV	 R42009 Str. MO
 R42012 Str. ML	 R42033 Str. ML	 R42048 Str. ML	 R48005 Str. RU	 R50004 Str. RU	 R50009 Str. VV	 R50016 Str. VV	 R50030 Str. ML	 R50080 Str. ML
 R50083 Str. MO	 R50084 Str. RU	 R55001 Str. RU	 R55004 Str. RU	 R55006 Str. RU	 R55007 Str. RU	 R55008 Str. RU	 R55011 Str. RU	 R55028 Str. MO
 R55032 Str. RU	 R55057 Str. RU	 R55058 Str. RU						

LOCKS

De lockers zijn standaard voorzien van een cilinderslot. Tip: bestel er een moedersleutel bij zodat je de lockers altijd makkelijk kunt openen. Nooit meer gedoe met kwijtgeraakte sleutels? Kies dan voor een mechanisch slot, pincode slot of een RFID slot.

The lockers are equipped as standard with a cylinder lock. Tip: order a master key so that you can open all the lockers easily. Want to

avoid the bother of lost keys? Opt for a mechanic lock, a pin code lock or a RFID lock.

Die Locker sind mit einem Zylinderschloss ausgestattet. Empfehlung: bestellen Sie einen Hauptschlüssel, damit Sie sich im Notfall jederzeit Zugang zu den Schränken verschaffen können. Keine Umstände mehr wegen verlorengangener Schlüssel?

Wählen Sie dann ein mechanisches Schloss, ein PIN-Code-Schloss oder ein RFID-Schloss.

Les casiers sont équipés de façon standard d'une serrure à cylindre. Conseil : commandez un passe-partout afin de toujours pouvoir ouvrir facilement les casiers. Si vous ne voulez plus de tracas avec des clés perdues, choisissez une serrure une serrure mécanique, une serrure à code PIN ou une serrure RFID.

LOCK WITH KEY



H/CS cylinder lock



H/MS coin lock

MECHANIC LOCKS



Lehmann 58 mechanic code lock



Sudhaus mechanic code lock (fixed user)

PIN CODE LOCKS



Mauer ELLcam Classic 1.2 pin code lock



Mauer ELLcam 2.0 pin code lock with timer function



Digilock Sola III pin code lock

RFID LOCKS



Mauer ELLcam 2.0 RFID with timer function



Digilock Sola III RFID



VECOS electronic locker-system

**MASTERKEYS
AVAILABLE
FOR ALL LOCKS**

ACCESSORIES

Er is meer mogelijk dan je denkt. Maak de lockers bijvoorbeeld af met nummerplaatjes of naamplaathouders. Wil je de kast vrij in de ruimte plaatsen? Dan bieden panelen voor de zij-, boven- en achterkant uitkomst.

More is possible than you might imagine. Add the finishing touch to the lockers with a number tag or name plate holder. Need

free-standing lockers? We have panels for the side, top and rear.

Es ist mehr möglich, als Sie denken. Versehen Sie die Schränke zum Beispiel mit nummerierten Schildern oder Befestigungen für Namensschilder. Möchten Sie den Schrank frei im Raum aufstellen? Dann empfehlen wir Ihnen die praktischen Seiten-, Deck- und Rückseitenpaneele.

Il existe plus de possibilités que vous ne pensez. Complétez les casiers avec par exemple des plaques à matricule ou des porte-

Si vous souhaitez placer le casier librement dans la pièce, les panneaux pour les côtés, plaques le dessus et l'arrière offrent une solution.

PANELS



End panel



Top panel



Back panel

NUMBER- AND NAMEPLATES

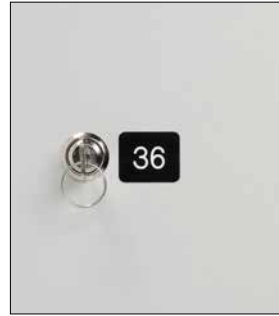

Number tag NP



Name plate holder NH1



Name plate holder with a lock-opening NH2



Name and number plate holder with a lock-opening NH3



Numbertag NH4 – horizontal



Numbertag NH4 – vertical



Card holder NH5



Key number tag SN



Plastic number PN

MAILBOX



Frame



Wall support

OTHER



Extra shelf



Letterslit

STEEL LOCKERS

AQUARIUS S

Design: van Esch team, The Netherlands



STEEL LOCKERS

AQUARIUS S

Design: van Esch team, The Netherlands

Veelzijdig, flexibel en stijlvol: met het uitgebreide Aquarius S lockerprogramma creëer je een oplossing die precies bij de ruimte past. De afsluitbare lockerkasten voelen zich overal thuis, en doen dienst als garderobekast of postvak. Verkrijgbaar in meer dan 20 kleuren.

Multipurpose, flexible and stylish: with the extensive Aquarius S locker programme you can create a solution that is perfect for the space. The steel lockable lockers feel right at home anywhere, and serve well as wardrobes or pigeonholes. Available in more than 20 colours.

Vielseitig, flexibel und stilvoll: mit dem vielseitigen Aquarius S Schrankprogramm kreieren Sie eine Lösung, die genau zum Raum passt. Die abschließbaren Schränke fühlen sich überall zuhause, und sie können als Garderobenschrank oder Postfach benutzt werden. In mehr als 20 Farben erhältlich.

Polyvalent, flexible et élégant : le système d'armoire Aquarius S vous permet d'opter pour une solution parfaitement adaptée à votre espace. Les armoires sont partout à leur place. Elles pourront servir de penderie ou de casier. Disponibles dans plus de 20 couleurs.



1x Aquarius SV2404/P

1x Aquarius SZ2402/P





Aquarius SV3404/P



Rabobank
Utrecht, The Netherlands
Aquarius SG3301/P special



Albert Schweitzer Hospital
Dordrecht, The Netherlands
3x Aquarius SZ3402/P
32 VAN ESCH

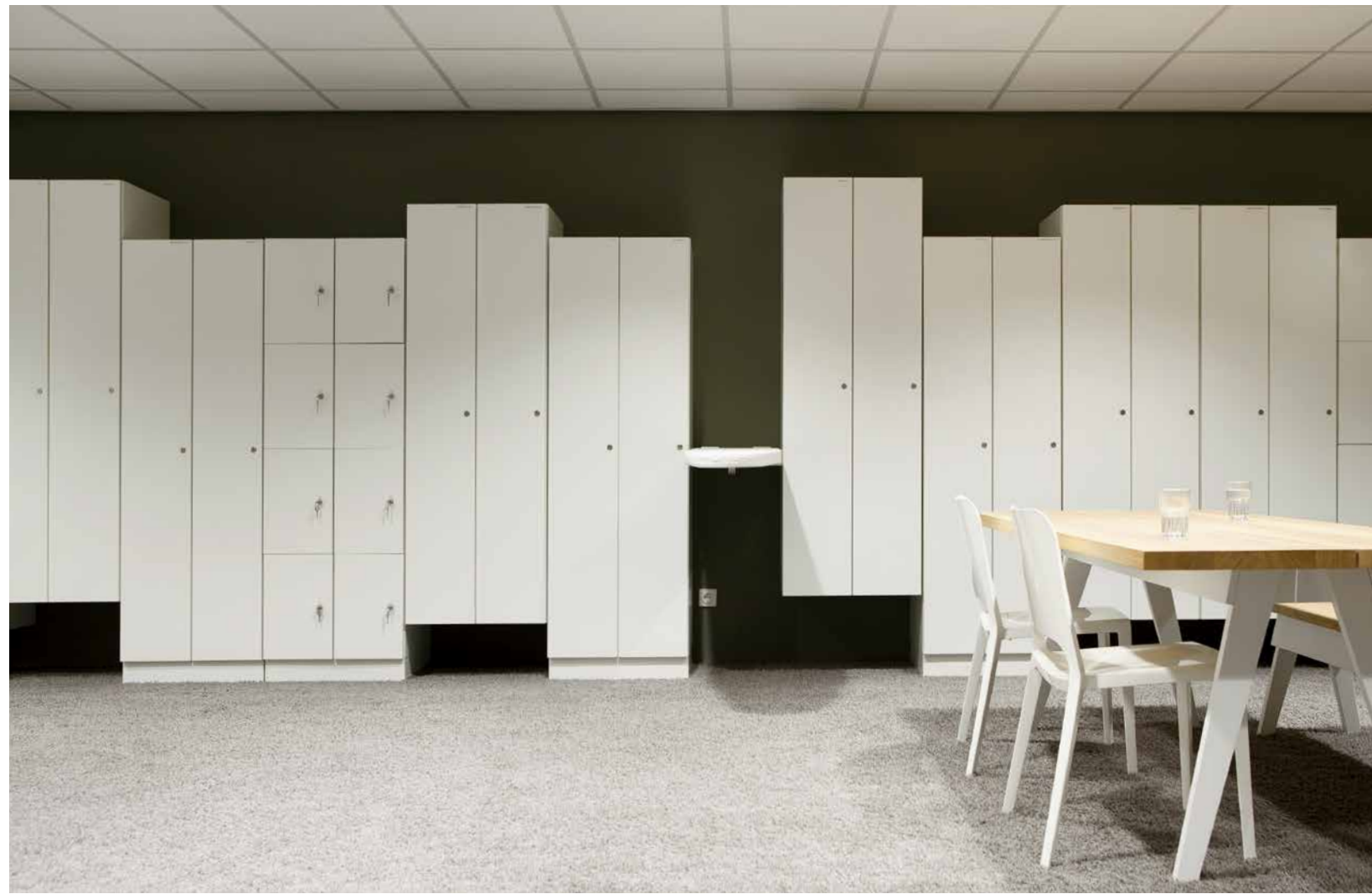

TNT
Hoofddorp, The Netherlands
Aquarius SZ2402/P
34 VAN ESCH

Frits Philips music centre
Eindhoven, The Netherlands
Aquarius SP1306 Aquarius SG2301/P

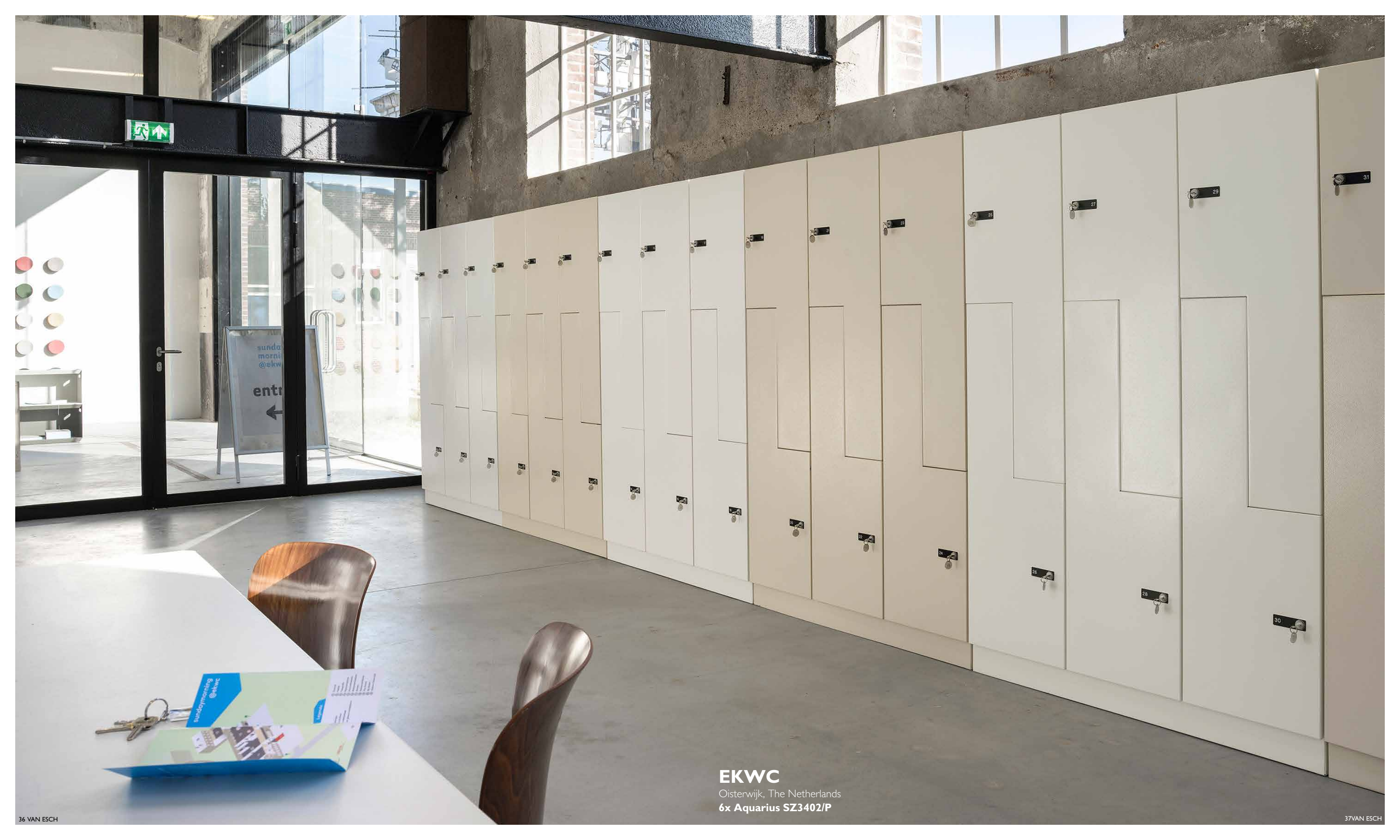

sunday morning
@ekwc
entr
←

EKWC

Oisterwijk, The Netherlands

6x Aquarius SZ3402/P

STEEL WARDROBE LOCKERS

AQUARIUS SG/P



WITH PLINTH

Specificaties

- Hoge kwaliteit locker
- Perfect voor projectgebruik
- Verkrijgbaar in 21 kleuren
- Standaard met cilinderslot of hangslot voorziening
- Inclusief legbord en hangerroede met verschuifbare haakjes
- Ventilatie in de achterwand
- Diverse sluitingsmogelijkheden

Specifications

- High-quality locker
- Perfect for project use
- Available in 21 colours
- With cylinder lock or padlock provision as standard
- Including shelf and hanging rod with sliding hooks
- Ventilation in back wall
- Various locking options

Spezifikationen

- Qualitativ hochwertige Schrank
- Perfekt für Raumkonzepte
- In 21 Farben erhältlich
- Standardmodell mit Zylinderschloss oder Drehriegel
- Einschließlich Ablagefach und Kleiderstange mit verschiebbaren Haken
- Lüftung in der Rückwand
- Verschiedene Schließmöglichkeiten

Spécifications

- Casier de qualité supérieure
- Parfait pour les projets
- Disponible en 21 couleurs
- Avec, de manière standard, une serrure à cylindre ou un fermeture pour cadenas
- Étagère et tringle avec crochets coulissants comprises
- Ventilation dans la paroi arrière
- Diverses possibilités de fermeture

MODELS

AQUARIUS SG/P

SG1301/P
SG1401/P
SG1501/P

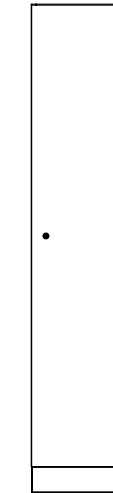

30/40/50 cm

SG2301/P
SG2401/P
SG2501/P

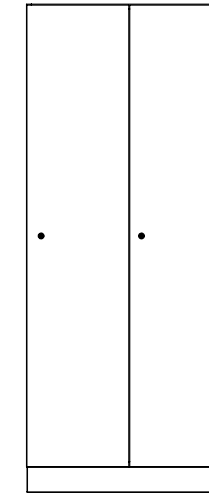

60/80/100 cm

SG3301/P
SG3401/P

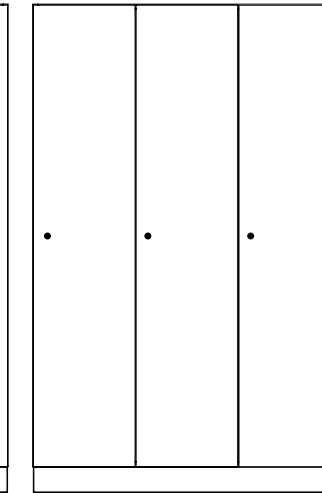

90/120 cm

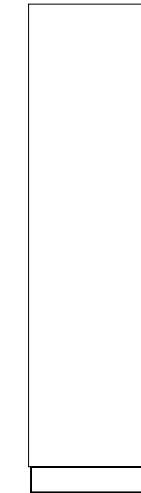

50 cm

180 cm

8 cm

SG1302/P
SG1402/P



30/40 cm

SG2302/P
SG2402/P

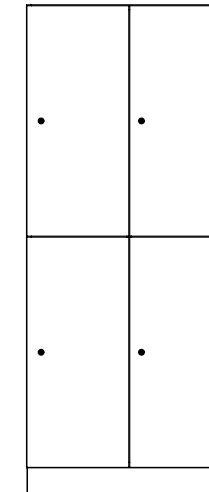

60/80 cm

SG3302/P
SG3402/P

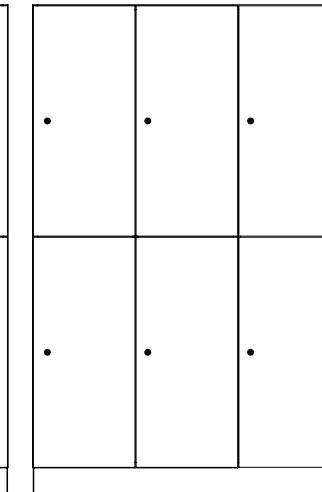

90/120 cm

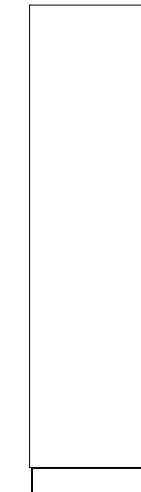

50 cm

180 cm

8 cm

STEEL WARDROBE LOCKERS

AQUARIUS SG/O



WITH FRAME

Specificaties

- Hoge kwaliteit locker
- Perfect voor projectgebruik
- Verkrijgbaar in 21 kleuren
- Standaard met cilinderslot of hangslot voorziening
- Inclusief legbord en hangerroede met verschuifbare haakjes
- Ventilatie in de achterwand
- Diverse sluitingsmogelijkheden

Specifications

- High-quality locker
- Perfect for project use
- Available in 21 colours
- With cylinder lock or padlock provision as standard
- Including shelf and hanging rod with sliding hooks
- Ventilation in back wall
- Various locking options

Spezifikationen

- Qualitativ hochwertige Schrank
- Perfekt für Raumkonzepte
- In 21 Farben erhältlich
- Standardmodell mit Zylinderschloss oder Drehriegel
- Einschließlich Ablagefach und Kleiderstange mit verschiebbaren Haken
- Lüftung in der Rückwand
- Verschiedene Schließmöglichkeiten

Spécifications

- Casier de qualité supérieure
- Parfait pour les projets
- Disponible en 21 couleurs
- Avec, de manière standard, une serrure à cylindre ou un fermeture pour cadenas
- Étagère et tringle avec crochets coulissants comprises
- Ventilation dans la paroi arrière
- Diverses possibilités de fermeture

MODELS

AQUARIUS SG/O

SG1301/O
SG1401/O
SG1501/O

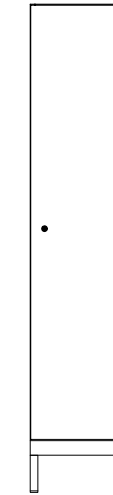

30/40/50 cm

SG2301/O
SG2401/O
SG2501/O

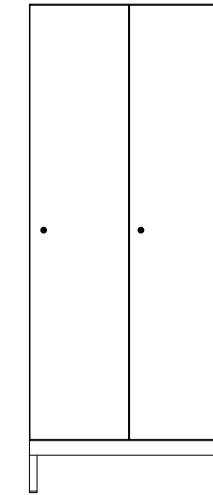

60/80/100 cm

SG3301/O
SG3401/O

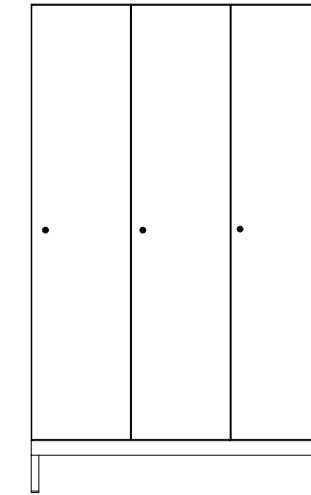

90/120 cm

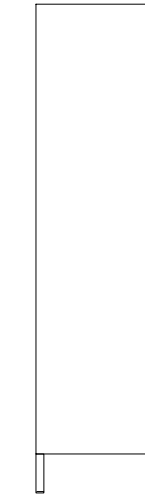

195 cm

8 cm
15 cm

50 cm

SG1302/O
SG1402/O

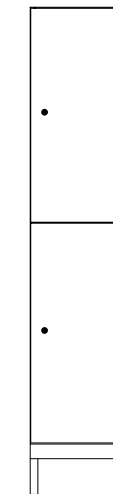

30/40 cm

SG2302/O
SG2402/O

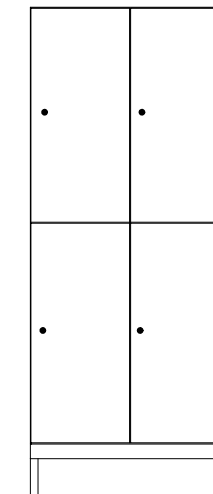

60/80 cm

SG3302/O
SG3402/O

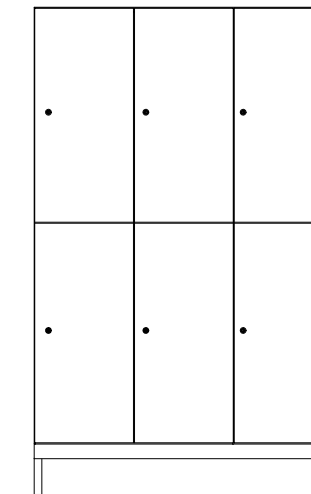

90/120 cm

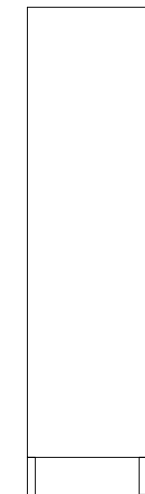

195 cm

8 cm
15 cm

50 cm

STEEL WARDROBE LOCKERS

AQUARIUS SG/OB



WITH BENCH

Specificaties

- Hoge kwaliteit locker
- Perfect voor projectgebruik
- Verkrijgbaar in 21 kleuren
- Standaard met cilinderslot of hangslot voorziening
- Inclusief legbord en hangerroede met verschuifbare haakjes
- Ventilatie in de achterwand
- Diverse sluitingsmogelijkheden

Specifications

- High-quality locker
- Perfect for project use
- Available in 21 colours
- With cylinder lock or padlock provision as standard
- Including shelf and hanging rod with sliding hooks
- Ventilation in back wall
- Various locking options

Spezifikationen

- Qualitativ hochwertige Schrank
- Perfekt für Raumkonzepte
- In 21 Farben erhältlich
- Standardmodell mit Zylinderschloss oder Drehriegel
- Einschließlich Ablagefach und Kleiderstange mit verschiebbaren Haken
- Lüftung in der Rückwand
- Verschiedene Schließmöglichkeiten

Spécifications

- Casier de qualité supérieure
- Parfait pour les projets
- Disponible en 21 couleurs
- Avec, de manière standard, une serrure à cylindre ou un fermeture pour cadenas
- Étagère et tringle avec crochets coulissants comprises
- Ventilation dans la paroi arrière
- Diverses possibilités de fermeture

MODELS

AQUARIUS SG/OB

SG1301/OB
SG1401/OB
SG1501/OB

SG2301/OB
SG2401/OB
SG2501/OB

SG3301/OB
SG3401/OB

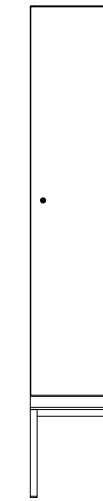

30/40/50 cm

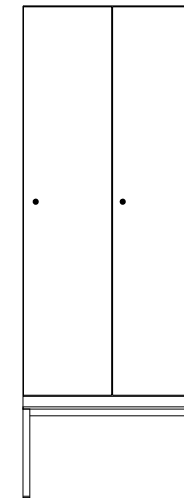

60/80/100 cm

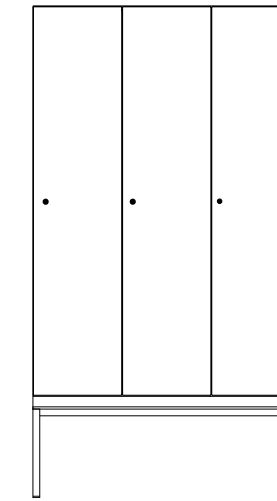

90/120 cm

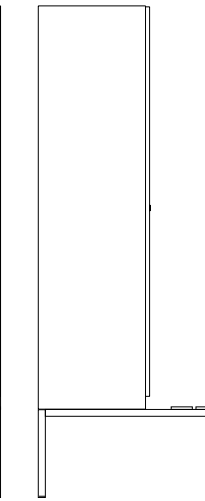

50 cm

80 cm

220,5 cm

18 cm
40,5 cm

SG1302/OB
SG1402/OB

SG2302/OB
SG2402/OB

SG3302/OB
SG3402/OB

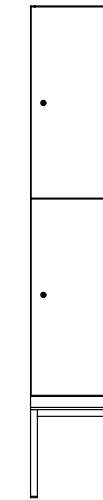

30/40cm

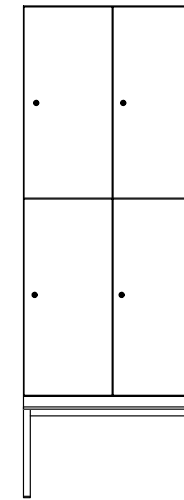

60/80 cm

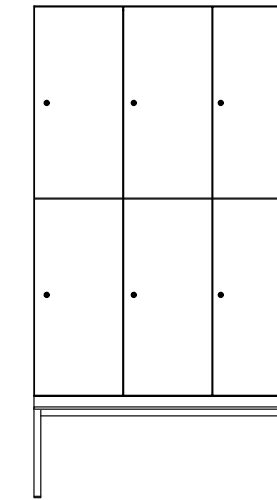

90/120 cm

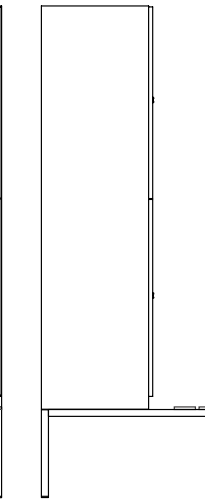

50 cm

80 cm

220,5 cm

18 cm
40,5 cm

STEEL Z-SHAPED LOCKERS AQUARIUS SZ



WITH PLINTH

Specificaties

- Hoge kwaliteit locker
- Perfect voor projectgebruik
- Verkrijgbaar in 21 kleuren
- Standaard met cilinderslot of hangslot-voorziening
- Verkrijgbaar met plint, frame of bank
- Inclusief legbord en hangerroede met verschuifbare haakjes
- Ventilatie in de achterwand
- Diverse sluitingsmogelijkheden

Specifications

- High-quality locker
- Perfect for project use
- Available in 21 colours
- With cylinder lock or padlock provision as standard
- Available with plinth, frame or bench
- Including shelf and hanging rod with sliding hooks
- Ventilation in back wall
- Various locking options



WITH FRAME

Spezifikationen

- Qualitativ hochwertige Schrank
- Perfekt für Raumkonzepte
- In 21 Farben erhältlich
- Standardmodell mit Zylinderschloss oder Drehriegel
- Erhältlich mit Sockel, Rahmen oder Bank
- Einschließlich Einlegeboden und Kleiderstange mit verschiebbaren Haken
- Entlüftung in der Rückwand
- Verschiedene Schließmöglichkeiten

Spécifications

- Casier de qualité supérieure
- Parfait pour les projets
- Disponible en 21 couleurs
- Avec, de manière standard, une serrure à cylindre ou un fermeture pour cadenas
- Disponible avec plinthe, châssis ou banc
- Étagère et tringle avec crochets coulissants comprises
- Ventilation dans la paroi arrière
- Diverses possibilités de fermeture



WITH BENCH

MODELS AQUARIUS SZ

SZ1402/P
SZ1502/P

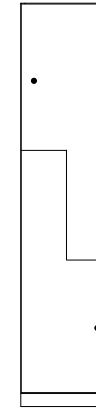

40/50 cm

SZ2402/P
SZ2502/P

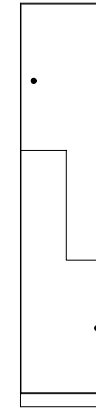

80/100 cm

SZ3402/P

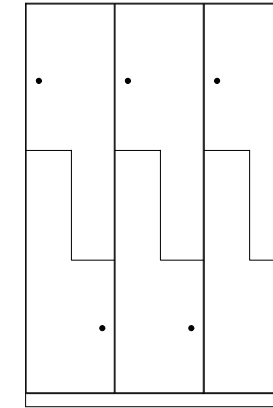

120 cm

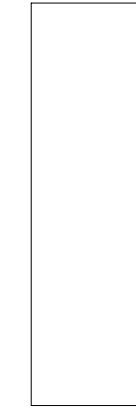

180 cm

8 cm

50 cm

SZ1402/O
SZ1502/O

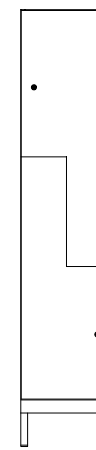

40/50 cm

SZ2402/O
SZ2502/O

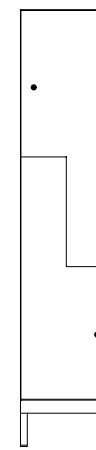

80/100 cm

SZ3402/O

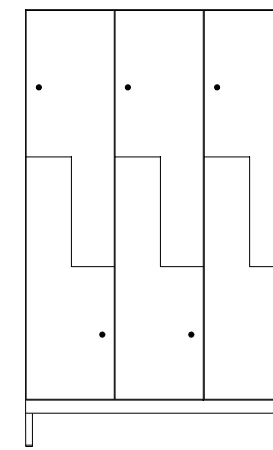

120 cm

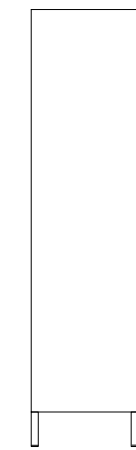

195 cm

8 cm

15 cm

50 cm

SZ1402/OB
SZ1502/OB

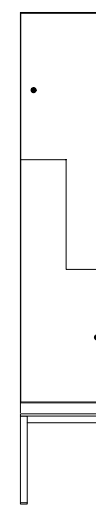

40/50 cm

SZ2402/OB
SZ2502/OB

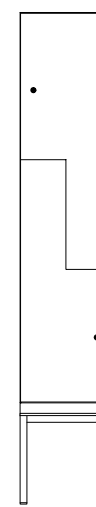

80/100 cm

SZ3402/OB

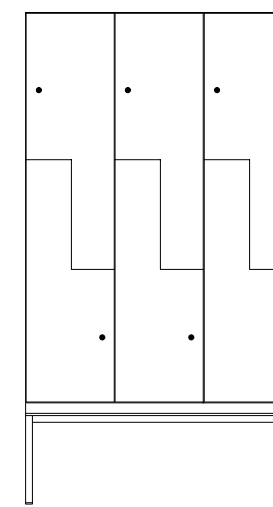

120 cm

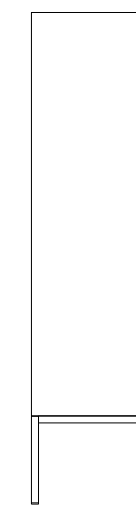

220,5 cm

8 cm

40,5 cm

50 cm

80 cm

STEEL COMPARTMENT LOCKERS AQUARIUS SV



WITH PLINTH

Specificaties

- Hoge kwaliteit locker
- Perfect voor projectgebruik
- Verkrijgbaar in 21 kleuren
- Standaard met cilinderslot of hangslotvoorziening
- Diverse sluitingsmogelijkheden

Specifications

- High-quality locker
- Perfect for project use
- Available in 21 colours
- With cylinder lock or padlock provision as standard
- Various locking options

Spezifikationen

- Qualitativ hochwertige Schrank
- Perfekt für Raumkonzepte
- In 21 Farben erhältlich
- Standardmodell mit Zylinderschloss oder Drehriegel
- Verschiedene Schließmöglichkeiten

Spécifications

- Casier de qualité supérieure
- Parfait pour les projets
- Disponible en 21 couleurs
- Avec, de manière standard, une serrure à cylindre ou un fermeture pour cadenas
- Diverses possibilités de fermeture

MODELS AQUARIUS SV

SV1303/P
SV1403/P

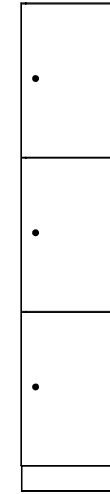

30/40 cm

SV2303/P
SV2403/P

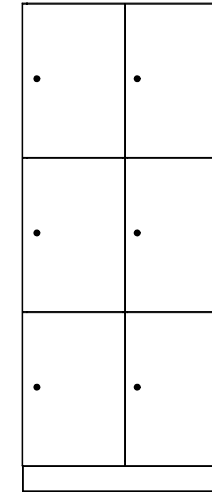

60/80 cm

SV3303/P
SV3403/P

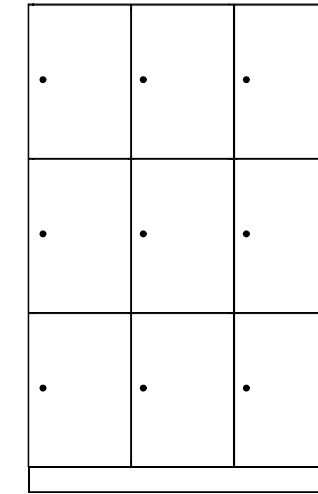

90/120 cm

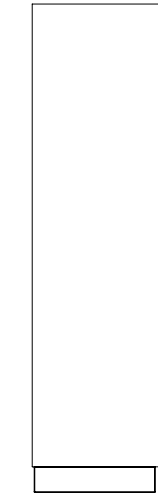

180 cm

8 cm

50 cm

SV1304/P
SV1404/P

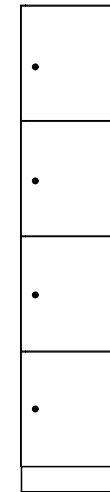

30/40 cm

SV2304/P
SV2404/P

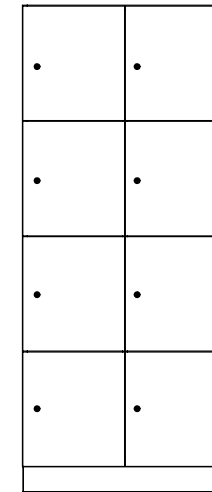

60/80 cm

SV3304/P
SV3404/P

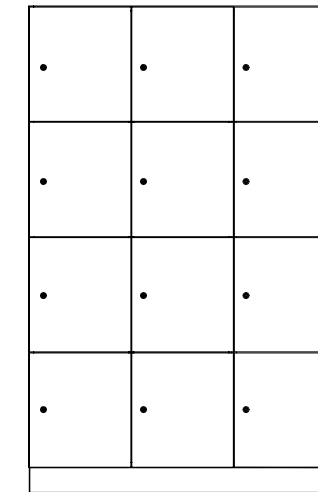

90/120 cm



180 cm

8 cm

50 cm

SV1305/P
SV1405/P

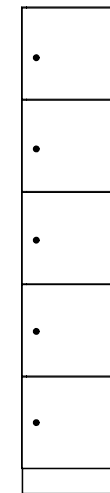

30/40 cm

SV2305/P
SV2405/P

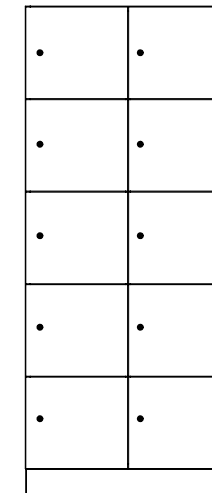

60/80 cm

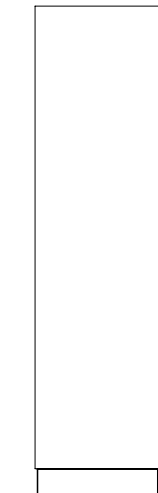

180 cm

8 cm

50 cm

COLOURS STEEL LOCKERS

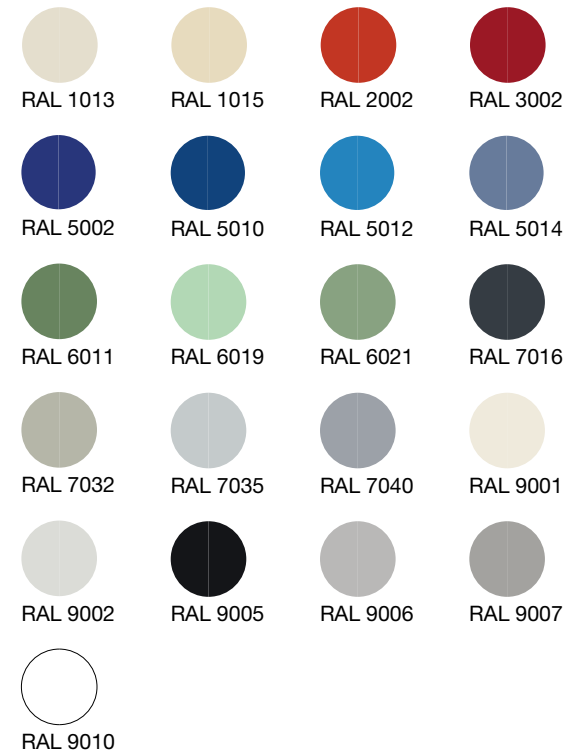

STEEL MAILBOX LOCKERS AQUARIUS SP



Specificaties

- Hoge kwaliteit locker
- Perfect voor projectgebruik
- Verkrijgbaar in 9 kleuren
- Standaard met cilinderslot
- Te combineren met een wandsteun of onderstel
- Diverse sluitingsmogelijkheden

Specifications

- High-quality locker
- Perfect for project use
- Available in 9 colours
- Cylinder lock as standard
- Can be combined with a wall support or frame
- Various locking options

Spezifikationen

- Qualitativ hochwertige Schrank
- Perfekt für Raumkonzepte
- In 9 Farben erhältlich
- Standardmodell mit Zylinderschloss
- Mit Wandhalterung oder Untergestell kombinierbar
- Verschiedene Schließmöglichkeiten

Spécifications

- Casier de qualité supérieure
- Parfait pour les projets
- Disponible en 9 couleurs
- Avec, de manière standard, une serrure à cylindre
- Peut être associé à un support mural ou à une base
- Diverses possibilités de fermeture

MODELS AQUARIUS SP

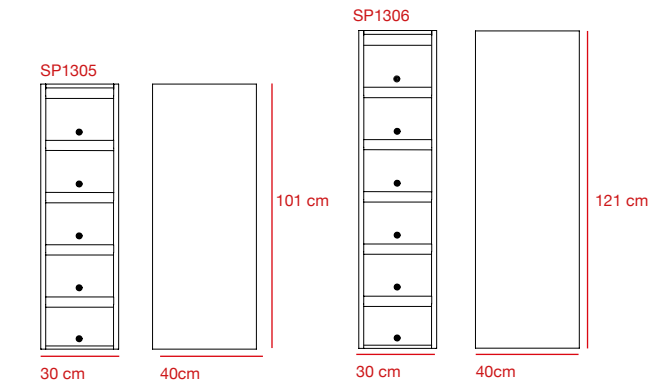

COLOURS MAILBOX LOCKERS

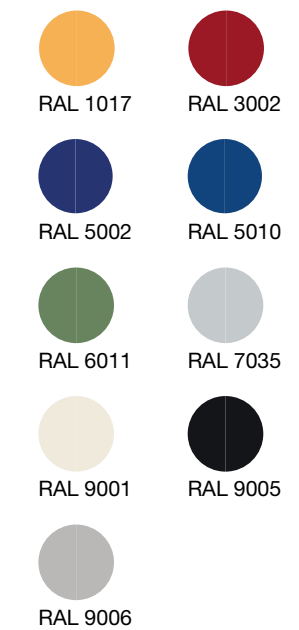

LOCKS

De lockers zijn standaard voorzien van een cilinderslot. Tip: bestel er een moedersleutel bij zodat je de lockers altijd makkelijk kunt openen. Nooit meer gedoe met kwijtgeraakte sleutels? Kies dan voor een mechanisch slot, pincode slot of een RFID slot.

The lockers are equipped as standard with a cylinder lock. Tip: order a master key so that you can open all the lockers easily. Want to

avoid the bother of lost keys? Opt for a mechanic lock, a pin code lock or a RFID lock.

Die Locker sind mit einem Zylinderschloss ausgestattet. Empfehlung: bestellen Sie einen Hauptschlüssel, damit Sie sich im Notfall jederzeit Zugang zu den Schränken verschaffen können. Keine Umstände mehr wegen verlorengegangener Schlüssel? Wählen Sie dann ein mechanisches Schloss,

ein PIN-Code-Schloss oder ein RFID-Schloss.

Les casiers sont équipés de façon standard d'une serrure à cylindre. Conseil : commandez un passe-partout afin de toujours pouvoir ouvrir facilement les casiers. Si vous ne voulez plus de tracas avec des clés perdues, choisissez une serrure une serrure mécanique, une serrure à code PIN ou une serrure RFID.

LOCK WITH KEY



S/CS cylinder lock



S/MS coin lock

MECHANIC LOCKS



Lehmann 58 mechanic code lock



Sudhaus mechanic code lock (fixed user)

PIN CODE LOCKS



Mauer ELLcam Classic 1.2 pin code lock



Mauer ELLcam 2.0 pin code lock with timer function

RFID LOCKS



Mauer ELLcam 2.0 RFID with timer function



Digilock Sola III RFLD

MASTERKEYS AVAILABLE FOR ALL LOCKS



Digilock Sola III pin code lock

VENTILATIONS



Ventilation grilles in the door



Ventilation in the rear wall

ACCESSORIES

Er is meer mogelijk dan je denkt. Maak de lockers bijvoorbeeld af met nummerplaatjes of naamplaathouders. Wil je de kast vrij in de ruimte plaatsen? Dan bieden panelen voor de zij-, boven- en achterkant uitkomst.

More is possible than you might imagine. Add the finishing touch to the lockers with a number tag or name plate holder. Need

free-standing lockers? We have panels for the side, top and rear.

Es ist mehr möglich, als Sie denken. Versetzen Sie die Schränke zum Beispiel mit nummerierten Schildern oder Befestigungen für Namensschilder. Möchten Sie den Schrank frei im Raum aufstellen? Dann empfehlen wir Ihnen die praktischen

free-standing lockers? We have panels for the side, top and rear.

Seiten-, Deck- und Rückseitenpaneele.

Il existe plus de possibilités que vous ne pensez. Complétez les casiers avec par exemple des plaques à matricule ou des porte-. Si vous souhaitez placer le casier librement dans la pièce, les panneaux pour les côtés, plaques le dessus et l'arrière offrent une solution.

NUMBER- AND NAMEPLATES

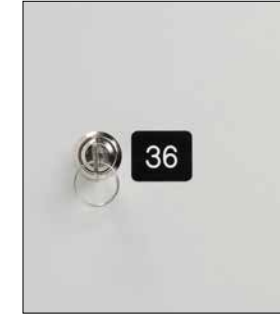

Number tag NP



Name plate holder NH1



Name plate holder with a lock-opening NH2



Name and number plate holder with a lock-opening NH3



Number tag NH4 - horizontal



Number tag NH4 - vertical

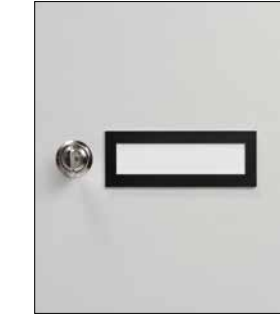

Card holder NH5



Key number tag SN



Plastic number PN



Letter-slit



Perforated door



Inclined upper panel

OTHER



Extra shelf



Letter-slit



Perforated door



Inclined upper panel

STEEL LOCKERS
ATLANTIS

Design: van Esch team, The Netherlands



STEEL LOCKERS

ATLANTIS

Design: van Esch team, The Netherlands

Berg persoonlijke eigendommen veilig op met lockerprogramma Atlantis: een ingetogen oplossing voor scholen, kantoren en sportverenigingen. De stalen lockerkasten zijn voorzien van cilindersloten en verkrijgbaar in wit.

Store your personal property safely with the Atlantis locker programme: a basic solution for schools, offices and sports clubs. The steel lockers have cylinder locks and are available in white.

Bewahren Sie persönliches Eigentum sicher im Schrankprogramm Atlantis auf: die schlichte Lösung für Schulen, Büros und Sportvereine. Die Stahlschränke sind mit Zylinderschlössern ausgestattet und in weiß erhältlich.

Rangez vos effets personnels en toute sécurité : une solution sobre pour l'école, le bureau et les associations sportives. Les armoires métalliques sont équipées de serrures à cylindre. Disponible en blanc.



Atlantis SV2304

Atlantis SG3402

Atlantis SG2401

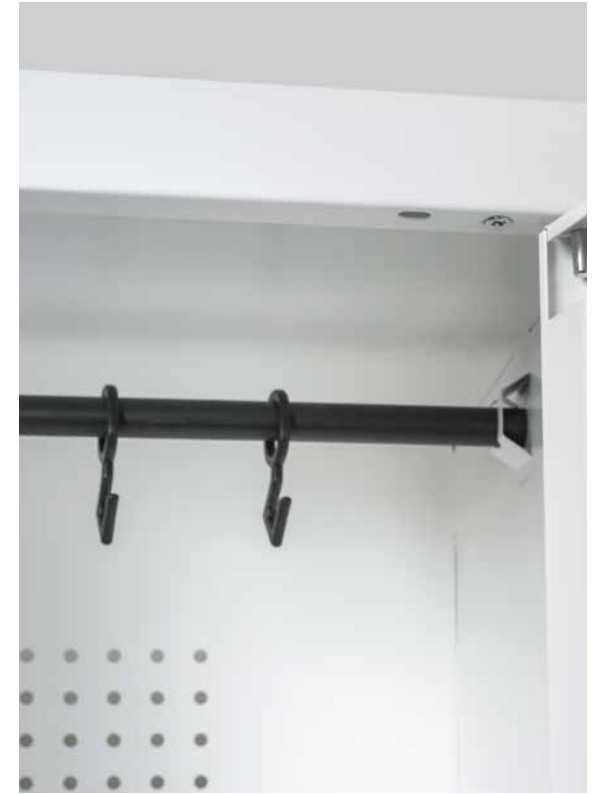



STEEL WARDROBE LOCKERS

ATLANTIS SG



Specificaties

- Basic locker
- Zonder plint
- Verkrijgbaar in 1 kleur
- Voorzien van cilindersloten
- Per opstelling altijd 2 zijpanelen bestellen i.v.m. koppelgaten in de romp
- Inclusief legbord, hangerroede met verschuifbare haken, spiegel en naamplaat houder

Specifications

- Basic locker
- Without plinth
- Available in 1 colour
- Supplied with cylinder locks
- Always order two end panels per configuration because of the perforation for connecting the lockers
- Including shelf, hanging rod with sliding hooks, mirror and name plate holder

Spezifikationen

- Basic Schrank
- Ohne Sockel
- In 1 Farbe erhältlich
- Mit Zylinderschloss ausgestattet
- Bestellen Sie pro Aufstellung 2 Endplatte wegen Locher zur Verbindung der Schränke
- Einschließlich Einlegeboden, Kleiderstange mit verschiebbaren Haken, Spiegel und Namensschilder

Spécifications

- Casier de base
- Sans plinthe
- Disponible en 1 couleur
- Équipé de serrures à cylindre
- Pro placement commandez-vous 2 panneaux à finition parce que il y a des trous pour joindre des armoires
- Étagère, tringle avec crochets coulissants, miroir et porte-plaque compris

MODELS

ATLANTIS SG

SG2301
SG2401

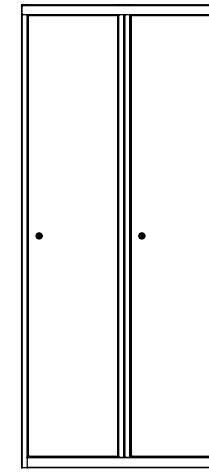

60/80 cm

SG3301
SG3401

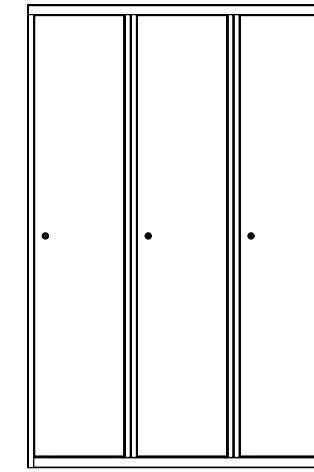

90/120 cm

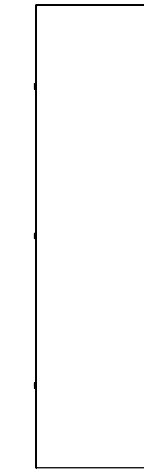

50 cm

180 cm

SG2302
SG2402

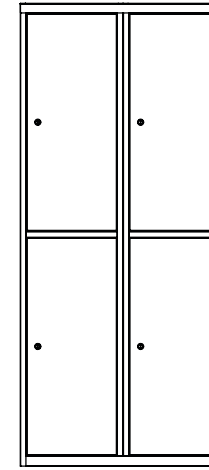

60/80 cm

SG3302
SG3402

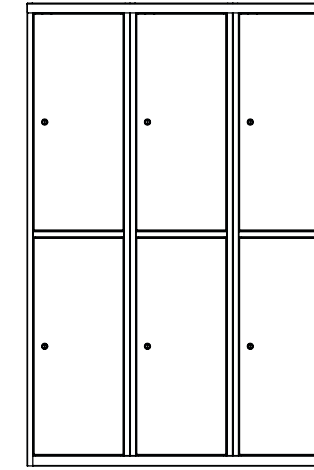

90/120 cm

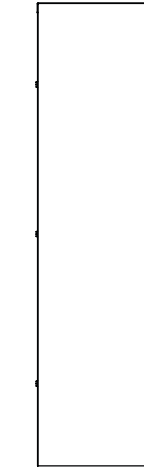

50 cm

180 cm

STEEL Z-SHAPED LOCKERS ATLANTIS SZ



Specificaties

- Basic locker
- Zonder plint
- Verkrijgbaar in 1 kleur
- Voorzien van cilindersloten
- Per opstelling altijd 2 zijpanelen bestellen i.v.m. koppelgaten in de romp
- Inclusief legbord, hangerroede met verschuifbare haken, spiegel en naamplaat houder

Specifications

- Basic locker
- Without plinth
- Available in 1 colour
- Supplied with cylinder locks
- Always order two end panels per configuration because of the perforation for connecting the lockers
- Including shelf, hanging rod with sliding hooks, mirror and name plate holder

Spezifikationen

- Basic Schrank
- Ohne Sockel
- In 1 Farbe erhältlich
- Mit Zylinderschloss ausgestattet
- Bestellen Sie pro Aufstellung 2 Endplatte wegen Locher zur Verbindung der Schränke
- Einschließlich Einlegeboden, Kleiderstange mit verschiebbaren Haken, Spiegel und Namensschilder

Spécifications

- Casier de base
- Sans plinthe
- Disponible en 1 couleur
- Équipé de serrures à cylindre
- Pro placement commandez-vous 2 panneaux à finition parce que il y a des trous pour joindre des armoires
- Étagère, tringle avec crochets coulissants, miroir et porte-plaque compris

MODELS ATLANTIS SZ

SZ2302

SZ3402

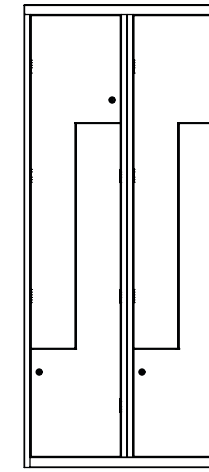

80 cm

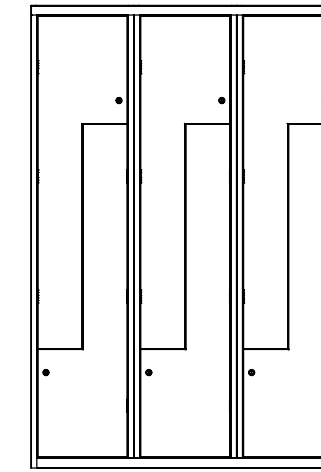

120 cm

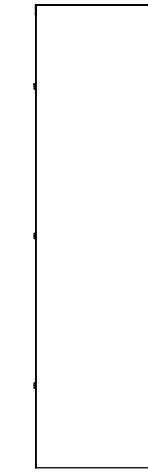

180 cm

50 cm

STEEL COMPARTMENT LOCKERS

ATLANTIS SV



Specificaties

- Basic locker
- Zonder plint
- Verkrijgbaar in 1 kleur
- Voorzien van cilindersloten
- Per opstelling altijd 2 zijpanelen bestellen i.v.m. koppelgaten in de romp
- Inclusief legbord, hangerroede met verschuifbare haken, spiegel en naamplaat houder

Specifications

- Basic locker
- Without plinth
- Available in 1 colour
- Supplied with cylinder locks
- Always order two end panels per configuration because of the perforation for connecting the lockers
- Including shelf, hanging rod with sliding hooks, mirror and name plate holder

Spezifikationen

- Basic Schrank
- Ohne Sockel
- In 1 Farbe erhältlich
- Mit Zylinderschloss ausgestattet
- Bestellen Sie pro Aufstellung 2 Endplatte wegen Locher zur Verbindung der Schränke
- Einschließlich Einlegeboden, Kleiderstange mit verschiebbaren Haken, Spiegel und Namensschilder

Spécifications

- Casier de base
- Sans plinthe
- Disponible en 1 couleur
- Équipé de serrures à cylindre
- Pro placement commandez-vous 2 panneaux à finition parce que il y a des trous pour joindre des armoires
- Étagère, tringle avec crochets coulissants, miroir et porte-plaque compris

MODELS

ATLANTIS SV

SV2303
SV2403

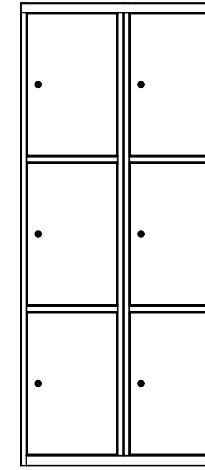

60/80 cm

SV3303
SV3403

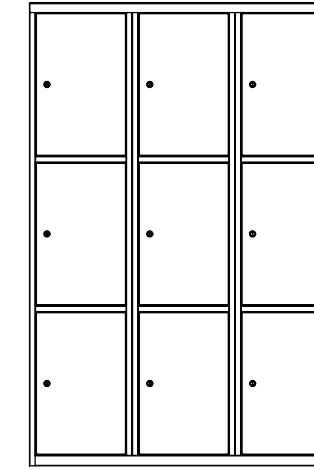

90/120 cm

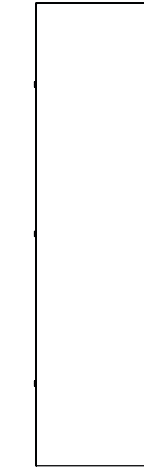

50 cm

180 cm

SV2304
SV2404

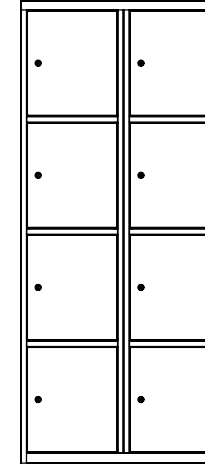

60/80 cm

SV3304
SV3404

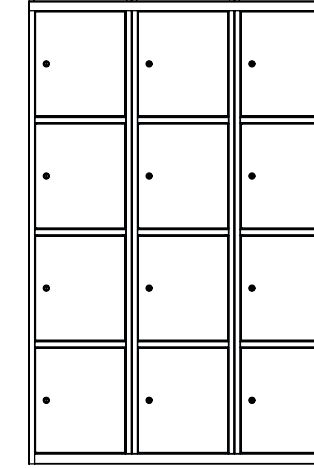

90/120 cm

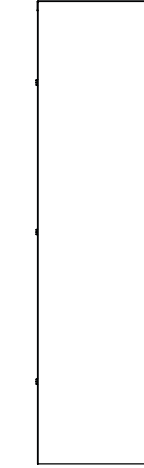

50 cm

180 cm

SV2305
SV2405

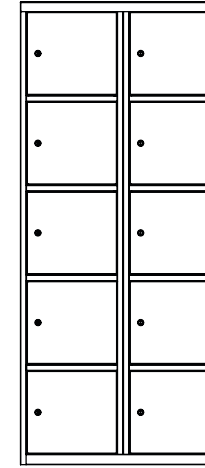

60/80 cm

SV3305
SV3405

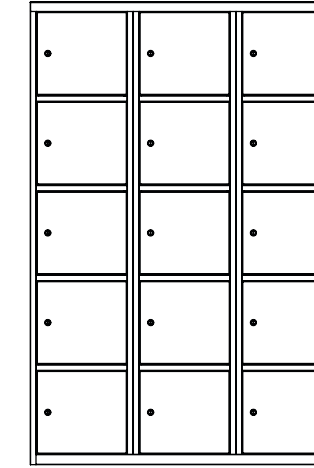

90/120 cm

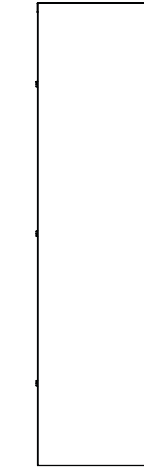

50 cm

180 cm

COLOUR



RAL 9010

LOCKS



S/CS cylinder lock

ACCESSORIES

PANELS



Inclined upper panel



End panel

PLINTH



Plinth

Special thanks to:

Interior Works
Royal Ahrend Group
SKO
Aarts & Co

Concept and design

Peer Dobbelsteen, 's-Hertogenbosch
The Netherlands

Photography

Inpetto fotografisch, Moergestel
The Netherlands
Isidoor van Esch, Amsterdam
The Netherlands

Styling

Gaby Hanrath, Amsterdam
The Netherlands

Copyright© van Esch 2020

All rights reserved

van Esch bv
Edisonstraat 5
NL-5051 DS GOIRLE
Tel. +31 (0)13 534 87 38
info@van-esch.com
www.van-esch.com



van Esch bv
Edisonstraat 5
NL-5051 DS GOIRLE
Tel. +31 (0)13 534 87 38
Fax +31 (0)13 534 87 60
info@van-esch.com
www.van-esch.com